

TT 5-A II

ACTIVE TWO-WAY SPEAKER

DESCRIPTION

Deploying a powerful 4" titanium compression driver, a large-sized constant directivity horn, and an incredibly fast neodymium 15" woofer, TT 5-A offers the highest performance from a wide dispersion, active, 2-way system. The TT 5-A is the ideal professional two-way speaker for high-grade live performance. The integration of an RDNet remote-controllable 1600 W, two-channel Class-D amplifier and the advanced FiRPHASE DSP 0° linear phase processing set new standards for clarity and efficiency.



FEATURES

- 134 dB max SPL
- 1600 W Class-D two-channel amplifier
- 90° x 50° constant directivity coverage
- FiRPHASE for 0° phase response
- Heavy-duty touring cabinet
- 32 bit - 96 kHz processing

TECHNICAL SPECIFICATIONS

Acoustical specifications	Frequency Response:	45 Hz ÷ 20000 Hz
	Max SPL @ 1m:	136 dB
	Horizontal coverage angle:	90°
	Vertical coverage angle:	50°
Transducers	Compression Driver:	1 x 1.4" neo, 4.0" v.c
	Woofers:	15" neo, 4.0" v.c
Input/Output section	Input signal:	bal/unbal
	Input connectors:	XLR, RDNet Ethercon
	Output connectors:	XLR, RDNet Ethercon
	Input sensitivity:	+4 dBu
Processor section	Crossover Frequencies:	650 Hz
	Protections:	Thermal, RMS
	Limiter:	Soft Limiter
	Controls:	Gain reduction, RDNet local setup/bypass, Time Delay, Presets (Linear, Close, Far listening, High- Pass), RDNet on board
	RDNet:	Yes
Power section	Total Power:	3200 W Peak, 1600 W RMS
	High frequencies:	1000 W Peak, 500 W RMS
	Low frequencies:	2200 W Peak, 1100 W RMS
	Cooling:	Convection
	Connections:	Powercon IN/OUT
Standard compliance	CE marking:	Yes
Physical specifications	Cabinet/Case Material:	Baltic birch plywood
	Hardware:	Installation/Rental fittings
	Handles:	2 side
	Pole mount/Cap:	Yes
	Grille:	Steel
	Color:	Black
Size	Height:	735 mm / 28.94 inches
	Width:	444 mm / 17.48 inches
	Depth:	529 mm / 20.83 inches
	Weight:	42.5 kg / 93.7 lbs
Shipping informations	Package Height:	870 mm / 34.25 inches
	Package Width:	630 mm / 24.8 inches
	Package Depth:	580 mm / 22.83 inches
	Package Weight:	47.5 kg / 104.72 lbs



PART NUMBER

- **13000631**

TT 5-A II

115V

EAN 8024530018009

- **13000630**

TT 5-A II







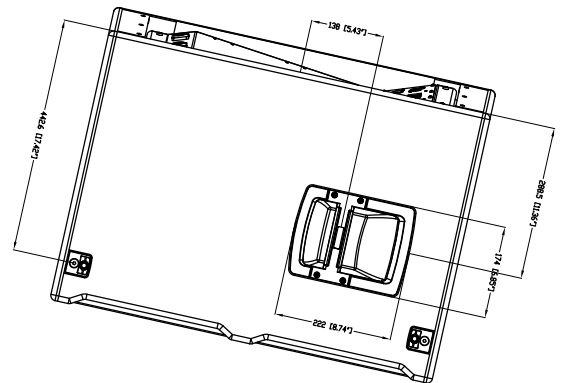
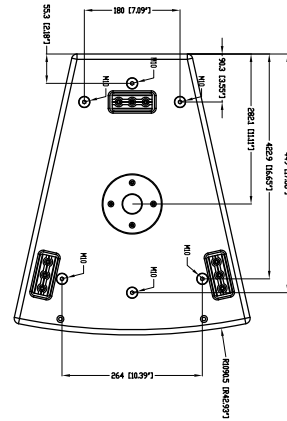
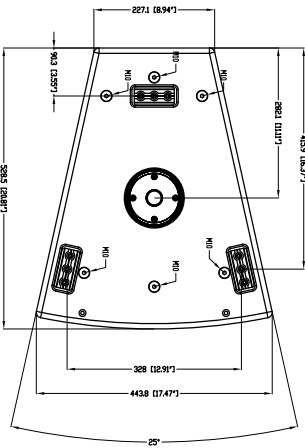
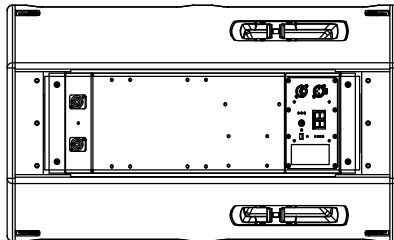
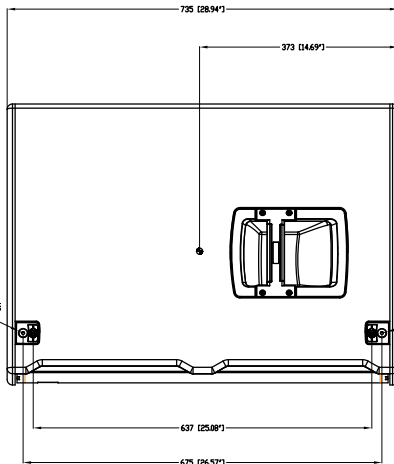
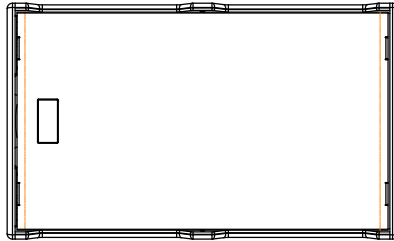

220-240V

EAN 8024530017996

TTS-A



ACCESSORIES

	AC PMA - POLE MOUNT	PART NUMBER EAN:	13360034 8024530007713
	AC PM-M20	PART NUMBER EAN:	13360067 8024530014599
	AC PMX POLE MOUNT M20	PART NUMBER EAN:	13360232 8024530010058
	AC PRO-PM PROFESS. LOCKING POLE MOUNT	PART NUMBER EAN:	13360110 8024530006488
	COVER CVR TT 5	PART NUMBER EAN:	13360246 8024530014056
	DOUBLE STUD 4X	PART NUMBER EAN:	13360030
	END BRACKET FOR CHAIN 2X AC TT5 END PL	PART NUMBER EAN:	13360268
	HORIZONTAL BRACKET H-BR TT 5	PART NUMBER EAN:	13360265 8024530016524
	KIT EYEBOLT 4 X	PART NUMBER EAN:	13360031



RAIN PROTECTION RP 1X TT 5

PART NUMBER **13360315**
EAN: 8024530012519



VERTICAL BRACKET V-BR TT 5

PART NUMBER **13360266**
EAN: 8024530016876
